

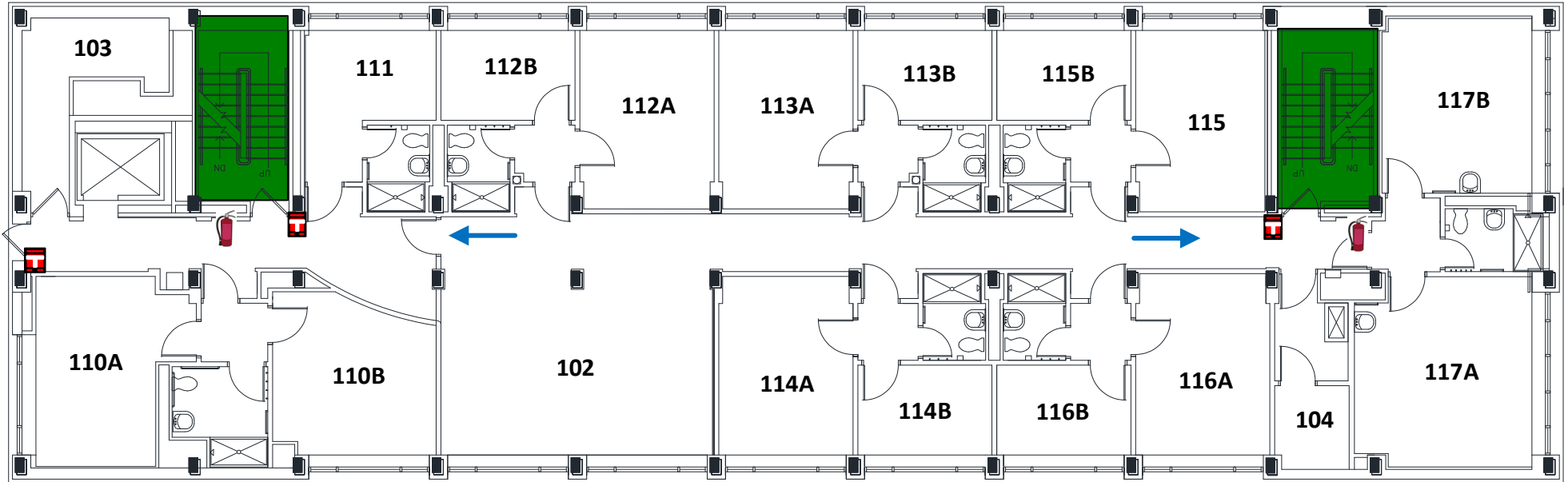





EMERGENCY EVACUATION ROUTE

Building Code: 937
 Building Name: Polk Street Residence Hall
 Floor Name: First Level
 Building Address: 1933 W Polk Street



Evacuation Assembly Area:

The sidewalk located on the north side of Polk Street which is located north of the Polk Street Residence Hall building.

	Stairway		Exit Pathway
	Fire Extinguisher		Storm Refuge Area
	Fire Alarm Pull Station		AED Location

**OFFICE OF
 THE VICE
 CHANCELLOR
 FOR
 ADMINISTRATIVE
 SERVICES**
